

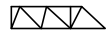

- SK1700 - 1.70x1.70 m
- SN2050 - 2.05x2.05 m

H=Altezza sotto gancio
H=Height under hook
H=Hauteur sous crochet

Torre/Reazioni – Masts/Reactions – Mat/Réactions – Maste/Eckdrücke – Mästil/Reacciones – Tramo/Reacções

SK1700

 33 m \rightarrow 58 m

Torre/Masts/Mat/Maste/Mästil/Tramo															
TRO	H[m]	4f/4f BF117	4f/4f BF052	4f/4f BF039	4f/2f SB117	4f/2f SB052	4f/2f SB039	2f/2f ST117	2f/2f ST052	2f/2f ST039	2f/2f STB117	2f/2f STB039	2f/2f RA039	4f/2f SBB039	4f/2f SBB117
	52	1	1		1			2							
	55.9	2			1			1	1	1					
TTD	52		3			1			6						
	46.8	1			1			2							
	35.1							3							
	55.9	2			1			1	1	1					
	59.8		4									7	1	1	
	50.7											6	1		1

Torre/Masts/Mat/Maste/Mästil/Tramo															
CAF	H[m]	4f/4f BF117	4f/4f BF052	4f/4f BF039	4f/2f SB117	4f/2f SB052	4f/2f SB039	2f/2f ST117	2f/2f ST052	2f/2f ST039	2f/2f STB117	2f/2f STB039	2f/2f RA039	4f/2f SBB039	4f/2f SBB117
	55.8	1			1			2		1					
	50.7							4		1					
	59.8	1			1			2		2					
	40.3							3							
	57.2		3			1		6							
	40.3											7	1	1	
	59.8											12	1	1	
	59.8	1										7	1		1

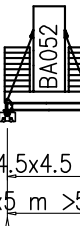
Torre/Masts/Mat/Maste/Mästil/Tramo															
CATR	H[m]	4f/4f BF117	4f/4f BF052	4f/4f BF039	4f/2f SB117	4f/2f SB052	4f/2f SB039	2f/2f ST117	2f/2f ST052	2f/2f ST039	2f/2f STB117	2f/2f STB039	2f/2f RA039	4f/2f SBB039	4f/2f SBB117
	52							4							
	52								9						
	40.3							3							
	45.5							3	1						
	33.8	1	1		1										
	52	1										5	1		1
	52											8	1		1
	50.7											11	1		

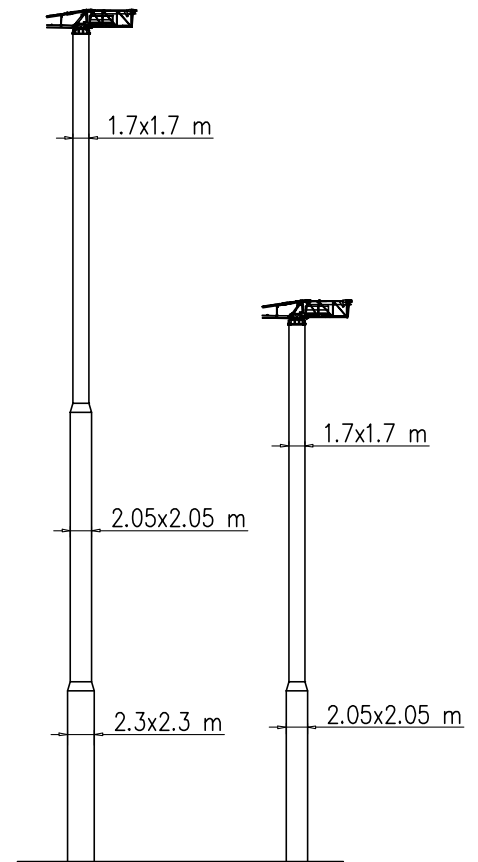

H=0-45 m		H=46-60 m	
R1	89 t	R1	106 t
R2	88 t	R2	106 t
R3	74 t	R3	95 t
M	194 tm	M	336 tm

Peso zavorra–Ballast weight–Poids du lest
Ballastgewicht–Peso de lastre

H	Tot.
0-35 m	60800 kg
36-45 m	72000 kg
46-60 m	116750 kg

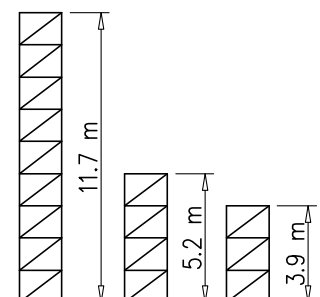

SN2050

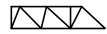
 33 m \rightarrow 58 m

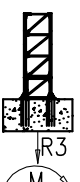
Torre/Masts/Mat/Maste/Mästil/Tramo															
TRO	H[m]	4f/4f BF117	4f/4f BF052	4f/4f BF039	4f/2f SB117	4f/2f SB052	4f/2f SB039	2f/2f ST117	2f/2f ST052	2f/2f ST039	2f/2f STB117	2f/2f STB039	2f/2f RA039	4f/2f SBB039	4f/2f SBB117
	62.4	2			1			2		1					
	61.1	1	1		1			2	1	1					
TTD	61.1		4			1			6	1					
	46.8							4							
	52	1	1		1			2							
*	62.4		3									10	1	1	
*	62.4	1										9	1		1
*	62.4	1										11	1	1	

Torre/Masts/Mat/Maste/Mästil/Tramo															
CAF	H[m]	4f/4f BF117	4f/4f BF052	4f/4f BF039	4f/2f SB117	4f/2f SB052	4f/2f SB039	2f/2f ST117	2f/2f ST052	2f/2f ST039	2f/2f STB117	2f/2f STB039	2f/2f RA039	4f/2f SBB039	4f/2f SBB117
	63.7	1			1			3							
	67.6	2			1			2							
	67.6		4			1			7						
	50.7		1			1		3							
	52				1			3							
*	65		3			1						9	1		
*	63.7	1										8	1		1
*	65.3	1				1						10	1		

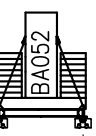
Torre/Masts/Mat/Maste/Mästil/Tramo															
CATR	H[m]	4f/4f BF117	4f/4f BF052	4f/4f BF039	4f/2f SB117	4f/2f SB052	4f/2f SB039	2f/2f ST117	2f/2f ST052	2f/2f ST039	2f/2f STB117	2f/2f STB039	2f/2f RA039	4f/2f SBB039	4f/2f SBB117
	59.8	1			1			2		2					
	59.8		3			1			5	2					
	45.5					1		3							
	49.4		1				1			9					
CATC	32.5				1			1		1					
*	59.8		3									8	1	1	
*	59.8	1										9	1	1	
*	59.8	1										7	1	1	

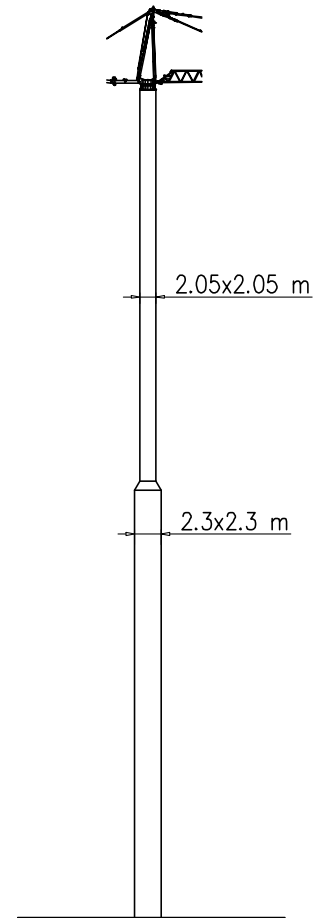

H=0-45 m		H=46-68 m	
R1	125 t	R1	140 t
R2	130 t	R2	144 t
R3	95 t	R3	103 t
M	486 tm	M	570 tm





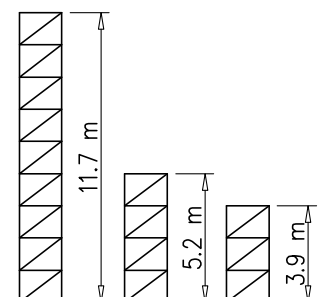

Peso zavorra-Ballast weight-Poids du lest
Ballastgewicht-Peso de lastre

H	Tot.
0-55 m	102320 kg
56-68 m	112460 kg

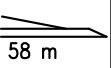

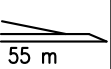

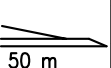

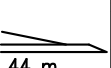

Curve di carico – Courbes de charges – Load diagrams – LastKurven – Curvas de cargas

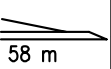

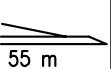

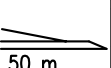

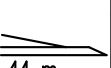
Pmax 5000 kg

	22000 kg		3.5	19	20	24	28	30	32	34	36	38	40	42	44	46	48	50	52	54	56	58	m
			5000	5000	4630	3780	3180	2940	2720	2540	2370	2220	2090	1970	1860	1760	1670	1580	1500	1430	1360	1300	kg
	22000 kg		3.5	21	24	28	30	32	34	36	38	40	42	44	46	48	50	52	54	55	m		
			5000	5000	4250	3580	3310	3080	2870	2680	2520	2370	2240	2110	2000	1900	1810	1720	1640	1600	kg		
	19560 kg		3.5	24	28	30	32	34	36	38	40	42	44	46	48	50	m						
			5000	5000	4280	3970	3690	3450	3230	3040	2860	2710	2560	2430	2310	2200	kg						
	17115 kg		3.5	23	24	28	30	32	34	36	38	40	42	44	m								
			5000	5000	4960	4190	3880	3610	3370	3160	2970	2800	2640	2500	kg								

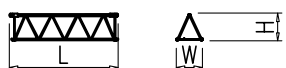
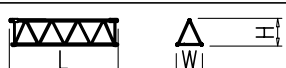
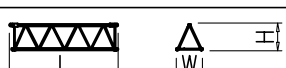
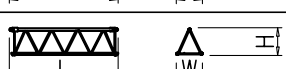
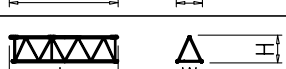
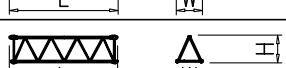
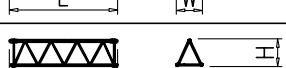
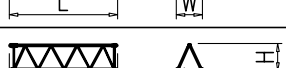
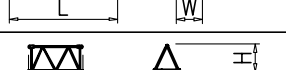
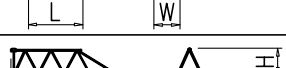
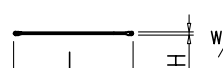



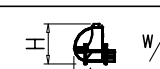
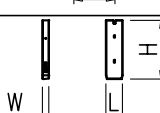





Pmax 10000/5000 kg

	22000 kg		3.5	11	12	16	20	24	28	30	32	34	36	38	40	42	44	46	48	50	52	54	56	58	m
			10000	10000	8300	5900	4630	3780	3180	2940	2720	2540	2370	2220	2090	1970	1860	1760	1670	1580	1500	1430	1360	1300	kg
	22000 kg		3.5	12	16	20	24	28	30	32	34	36	38	40	42	44	46	48	50	52	54	55	m		
			10000	10000	6600	5190	4250	3580	3310	3080	2870	2680	2520	2370	2240	2110	2000	1900	1810	1720	1640	1600	kg		
	19560 kg		3.5	14	16	20	24	28	30	32	34	36	38	40	42	44	46	48	50	m					
			10000	10000	8000	6180	5070	4280	3970	3690	3450	3230	3040	2860	2710	2560	2430	2310	2200	kg					
	17115 kg		3.5	14	16	20	24	28	30	32	34	36	38	40	42	44	m								
			10000	10000	8000	6040	4960	4190	3880	3610	3370	3160	2970	2800	2640	2500	kg								

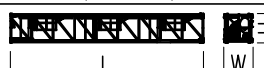
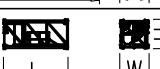
PESI E INGOMBRI – PACKING LIST – LISTE DE COLISAGE – GEWICHT UND ABMESSUNGEN

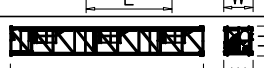
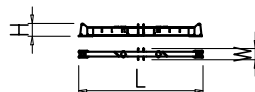
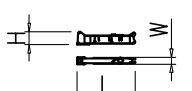
Denominazione Description	Disegno Draw	Pezzi Pieces	Dimensioni-Dimensions (mm)			Peso-Weight (kg)		
			L	W	H	Unit	Total	
Elemento di braccio Jib element Elément de èche Elemento de flecha	n°1 	1	5750	1400	1490	810	–	
	n°2 	1	5860	1400	1470	790	–	
	n°3 	1	5860	1400	1470	835	–	
	n°4 	1	5860	1400	1470	670	–	
	n°5 	1	5860	1400	1470	680	–	
	n°6 	1	5850	1400	1470	750	–	
	n°7 	1	5820	1400	1470	575	–	
	n°8 	1	5820	1400	1470	520	–	
	n°9 	1	5740	1400	1450	415	–	
	n°10 	1	2940	1400	1450	250	–	
	n°11 	1	5770	1400	1450	450	–	
Tirante completo Complete tie rod Tirant complète Tirante completo		9	6500	200	200	240	2160	
Cuspide Cusp Pointe Cùspide		1	6800	1500	1000	1550	–	
Contorbraccio completo Complete counterjib Contreflèche complète Contraflecha completa		1	8500	1650	600	1350	–	
Gruppo girevole Slewing group Table tournante Grupo giratorio		SK1700	1	5100	1810	1400	4100	–
		SN2050	1	5100	1810	1400	4300	–
Carrello Trolley Chariot Carretilla		1	1900	1620	1000	400	–	
Ballatoio con cabina Access balcony with cabin Porte cabine Balcòn corrido con cabina		1	2500	2150	2450	1000	–	
Blocchi contrappeso Counterweight block Contre-poids Bloques de contrapeso	VX24 	9	1100	280	3400	2445	22000	
Elemento di base Base element Mat de base Elemento de base		SK1700	1	5200	2060	2060	3650	–
		SN2050	1	5200	2260	2260	4040	–

PESI E INGOMBRI – PACKING LIST – LISTE DE COLISAGE – GEWICHT UND ABMESSUNGEN

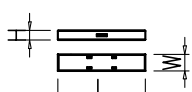
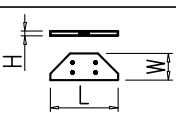
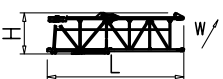
Denominazione Description	Disegno Draw	Pezzi Pieces	Dimensioni-Dimensions (mm)			Peso-Weight (kg)		
			L	W	H	Unit	Total	
Elemento di torre Mast element Elément de mature Elemento de torre	ST039 	SK1700	-	3900	1785	1785	1750	-
		SN2050	-	3900	2110	2110	2320	-
	ST052 	SK1700	-	5200	1785	1785	2250	-
		SN2050	-	5200	2110	2110	2850	-
	ST117 	SK1700	-	11700	1785	1785	4690	-
		SN2050	-	11700	2110	2110	5790	-
	SB039 	SK1700	-	3900	1785	1785	2100	-
		SN2050	-	3900	2110	2110	2710	-
	SB052 	SK1700	-	5200	1785	1785	2600	-
		SN2050	-	5200	2110	2110	3350	-
	SB117 	SK1700	-	11700	1785	1785	4830	-
		SN2050	-	11700	2110	2110	7000	-
BF039 	SK1700	-	3900	1785	1785	2450	-	
	SN2050	-	3900	2110	2110	3370	-	
BF052 	SK1700	-	5200	1785	1785	3390	-	
	SN2050	-	5200	2110	2110	3880	-	
BF117 	SK1700	-	11700	1785	1785	6920	-	
	SN2050	-	11700	2110	2110	8180	-	
Carro di base Base carriage Chassis de base Cruceta de base		4.5x4.5	1	6670	670	780	2040	2040
		5x5	1	7550	670	780	2300	2300
		6x6	1	8870	670	780	2500	2500
		4.5x4.5	2	3180	420	780	980	1960
		5x5	2	3530	420	780	1060	2120
		6x6	2	4320	420	780	1200	2400
Puntoni di base Rafter Jambes de force Cabrios de base		4.5x4.5	4	4070	240	300	270	1080
		5x5	4	4250	240	300	280	1120
		6x6	4	4560	420	300	420	1680
Elemento a perdere Disposable frame Chassis a perdre Bastidor desechable		SK1700	1	1840	1910	1910	1430	-
		SN2050	1	2600	2260	2260	2030	-
Elemento recuperabile Recoverable frame Chassis récupérable Bastidor recuperable		SK1700	1	1300	2170	2170	1720	-
		SN2050	1	1300	2620	2620	1860	-
Bogie di traslazione Driven bogie Boggie motorisèe Balancin de traslaciòn		4	1160	700	600	700	2800	
Blocco zavorra di base Base ballast block Lest de base Blaque de lastre		4.5x4.5	2	5000	750	600	5175	10350
		5x5	2	5300	1000	600	7300	14600
		6x6	2	6400	1200	600	10600	21200
		4.5x4.5	-	3600	1450	300	2800	-
		5x5	-	4100	1600	300	3500	-
		6x6	-	4800	2000	300	5070	-
Corsoio di montaggio Climbing cage Cage de montage Jaula de montaje		SK1700	1	8300	2600	2500	6000	-
		SN2050	1	8300	2900	2700	6700	-

GRU IN CAVEDIO – TELESCOPAGE SUR DALLES – CLIMBING CRANE – KLETTERKRANE IM GEBAUDE

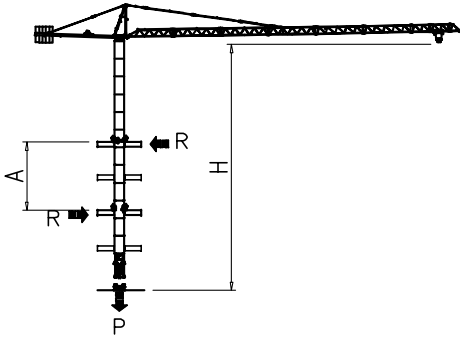

SN2050	H (m)	A (m)	R (t)	P (t)
	9	9	45.3	
	10	10	42	
	11	11	39.3	
	12	12	37	
	13	13	35	
	14	14	33.4	
	15	15	32	
	16	16	30.7	
	17	17	29.6	
	18	18	28.6	
	19	19	27.8	
	20	20	27	



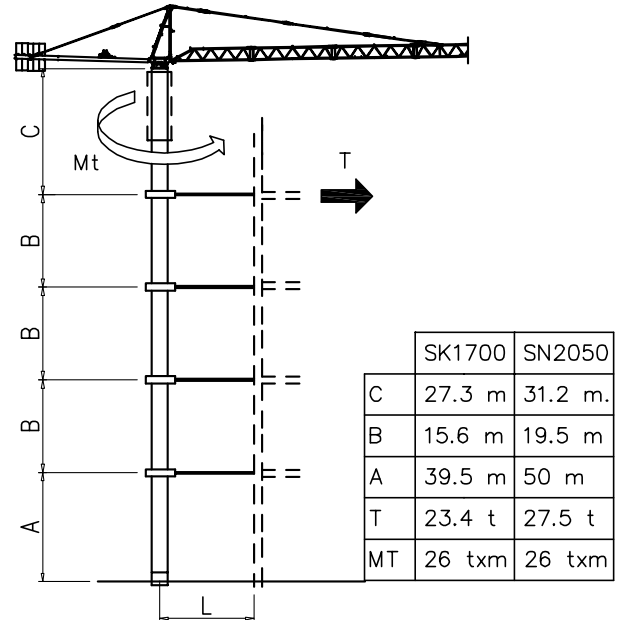
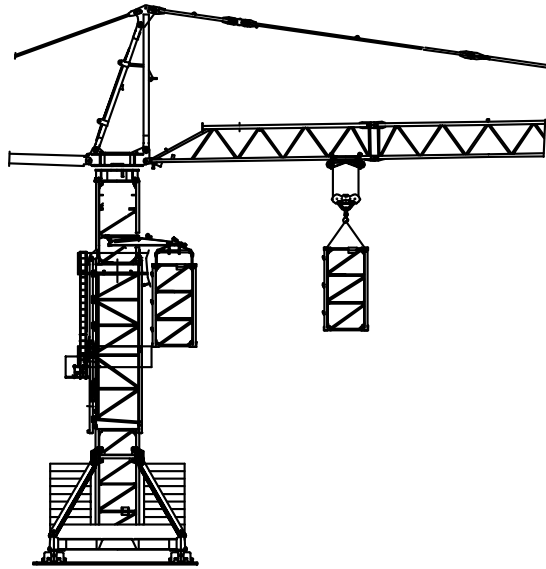

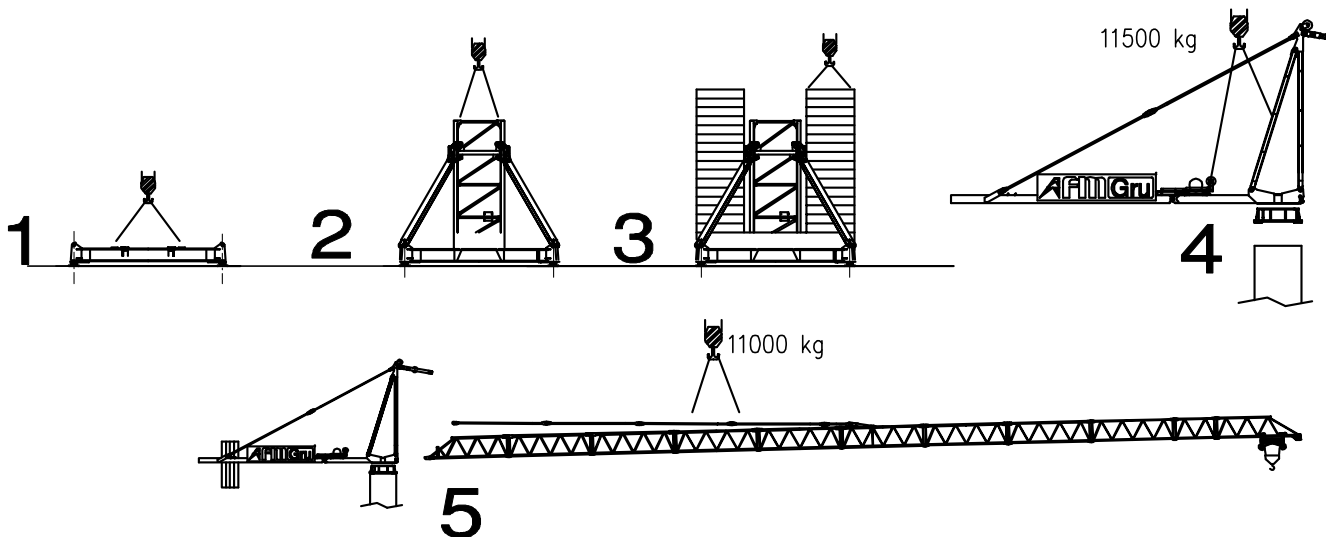

* SOPRALZO IDRAULICO – TELESCOPABLE – EXTERNAL CLIMBING – KLETTERKRANE



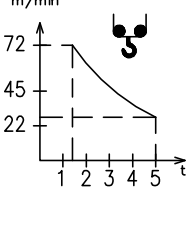
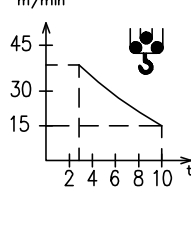
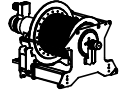

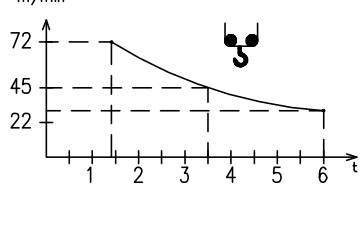
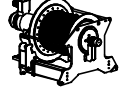

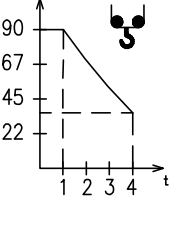
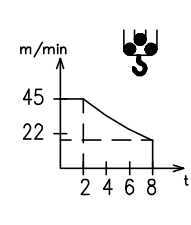
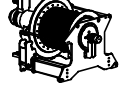
Montaggio – Montage – Erection – Montage – Montaje – Montagem

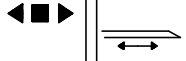

Meccanismi – Mechanisms – Mécanismes – Antriebe – Mecanismos

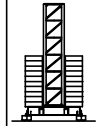
Sollevamento V45.60 Hoisting Levage Heben Elevaciòn Elevaçao									V45.60 33 kW 57 kVA  270 m 500 m (L)
	m/min	3	14	30	45	60			
	t	5	5	5	3.5	2.4	1.4		
									
	m/min	1.5	7	15	22.5	30	36		
t	10	10	10	7	4.8	2.8			
Sollevamento V45.60 Hoisting Levage Heben Elevaciòn Elevaçao								V45.60 33 kW 57 kVA  270 m 500 m (L)	
	m/min	3	14	30	45	60			72
	t	6	6	6	3.5	2.4	1.4		
									
	m/min	2	9	18	28	37	45		
t	8	8	8	6	4	1			
Sollevamento V45.90 Hoisting Levage Heben Elevaciòn Elevaçao									V45.90 33 kW 57 kVA  340 m 700 m (L)
	m/min	4	18	36	56	74			
	t	4	4	4	3	2	1		
									
	m/min	2	9	18	28	37	45		
t	8	8	8	6	4	1			

Carrello Trolleying Distribution Katzfahren Distribuciòn Distribuiçao		0 → 85	m/min	3.6 kW	Potenza elettrica necessaria Puissance électrique nécessaire Necessary electric power Anschlusswert – Potencia
Rotazione Slewing Orientation Schwenken Orientaciòn Rotaçao		0 → 0,9	giri/min tr/min rp/min	4.4 kW @ 1200rpm n° 2 x 2.2 kW	
Traslazione Travelling Translation Kranfahren Traslaciòn Traslaçao		0 → 20	m/min	7.5 kW	
Rete elettrica – Réseau – Mains supply – Netzstrom – Red – Rede electrica				400V – 50 Hz	
Rete elettrica – Réseau – Mains supply – Netzstrom – Red – Rede electrica				400V – 50 Hz	
 FMgru s.r.l. via Emilia 11-29010 Pontenure PC ITALY tel. 0523/510446 ric.aut. fax 0523/510365 www.fmgru.it e-mail: info@fmgru.com			FEM 1.001 2000/14/CE		



Documento commerciale non contrattuale
Per tutte le informazioni tecniche riferirsi
alle corrispondenti istruzioni

Unverbindliches Vertriebsdokument.
Für technische Informationen, siehe die
entsprechenden Anweisungen.

This commercial document is not legally
binding. For any technical information, please
refer to the corresponding instructions.

Documento comercial non contractual
Para cualquier información técnica,
ver la noticia correspondiente.

Code: 15ICA37K30A0		
Ed.	Data	Rev Data
1	05.06.03	2 17.03.10